

LRP 180QH

'SUPER' LONG-RANGE PIR

The MegaRed® is the world's first dual output external 'super' long-range PIR detector.

Ideal for large perimeter installations, the sensor provides separate 'near' and 'far' alarm outputs allowing the sensor to position an intruder in its field of view. When used with pan and tilt or dome cameras, the alarm outputs can be used to automatically position a camera to an area. Wiring to the detector from its controller can be made in two core cable. This two core carries power to the sensor, near and far alarm information and tamper simultaneously.

Due to their extended range and narrow fields of view, MegaRed® detectors should only be used over flat terrain.

The MegaRed® features a unique system to minimise cable and installation costs while maximising installation distance between detector and controller. The controller provides three separate relay outputs for near detection, far detection and tamper output and can be situated either at the detector head or in the control centre. The controller can be situated up to 800m away from the sensor.



COVERAGE

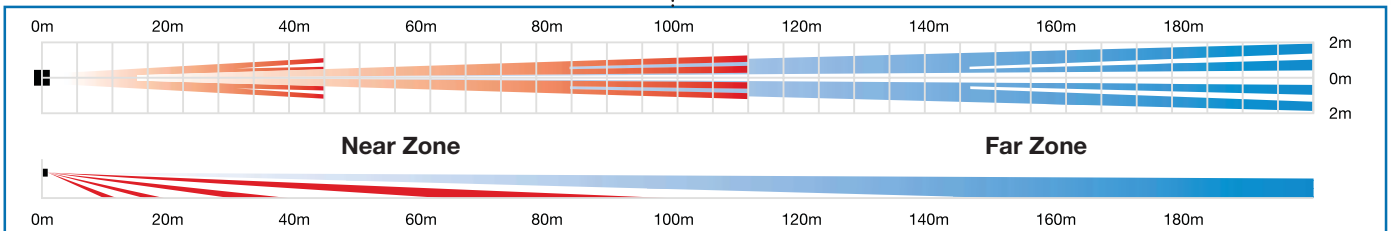

LRP 180QH
Coverage: 180 x 4m

DIMENSIONS

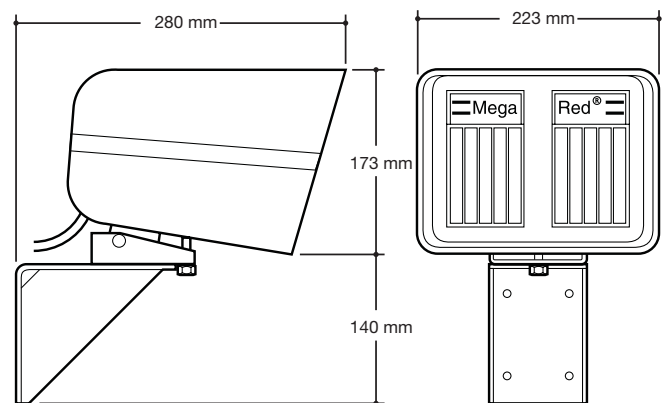

Dimensions vary depending on tilt of head











FEATURES

- Dual zone detection
- Two core wiring system
- Rugged construction
- Low power consumption
- Mounting bracket included
- Separate controller included
- IP65 rated
- Gold coated optical system
- Low temperature model

OPTIONS

- Sun/snow shield – LRPMEGAHOOD

SPECIFICATIONS

									
24 zones 6 Quad	11-16V DC	80mA	-40°C	+50°C	2.5m	5.3Kg	IP65	Output 2 x Form 1C 30VDC/1A (Max)	Tamper Form 1B 28VDC/100mA (Max)

Optex (Europe) Ltd.

For further information visit our website: www.optexeurope.com